

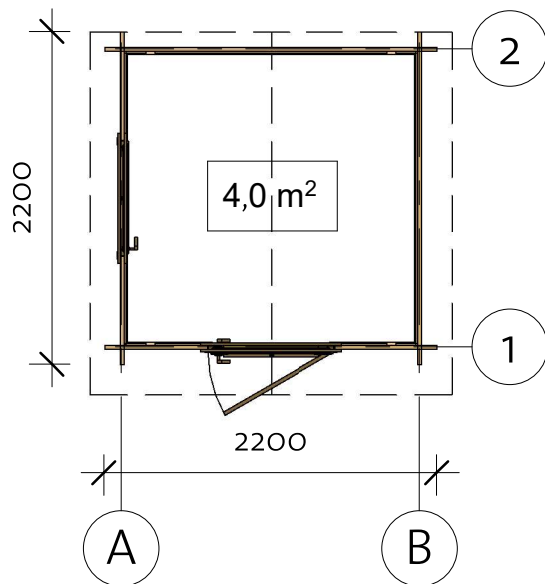

Dixon 28 (200x200)

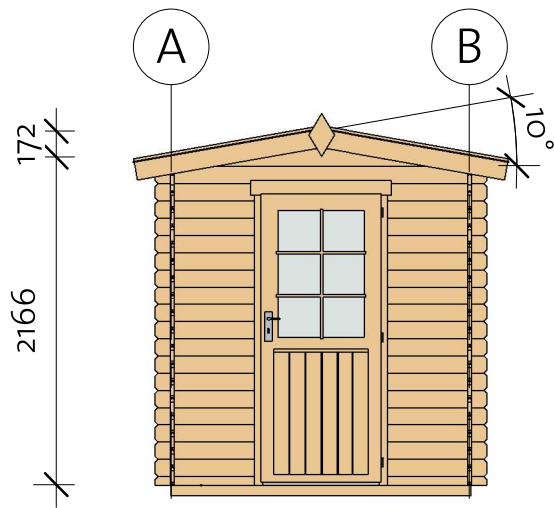
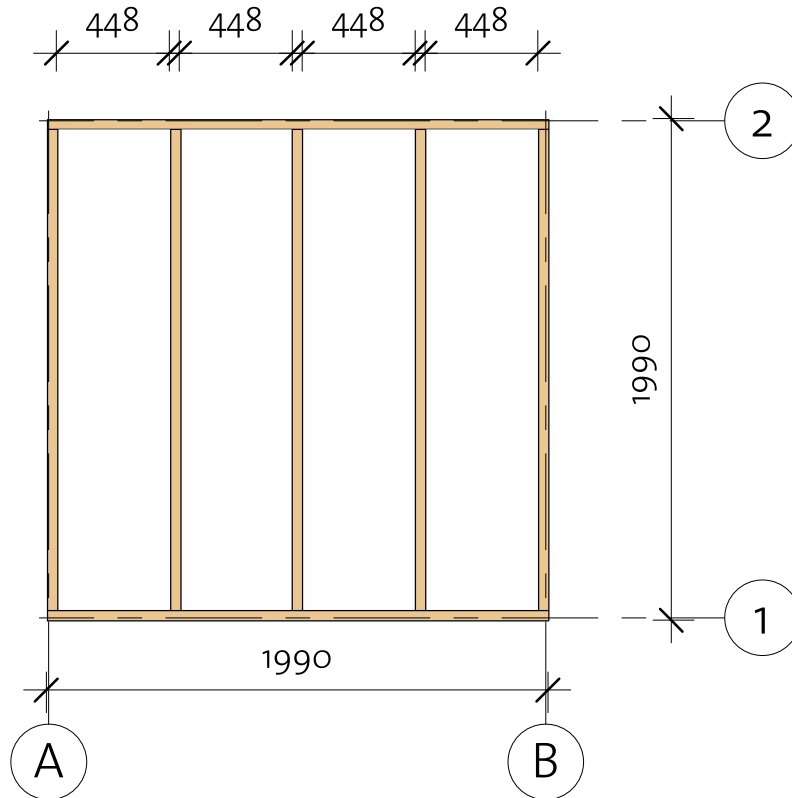

Dixon 28 (200x200)

Foundation



Impregnated foundation beams				
Mark	Type	Profile	Count	Length
IFB1	IFB 40x70		5	1910
IFB2	IFB 40x70		2	1990



Dixon 28 (200x200)

Floor plan

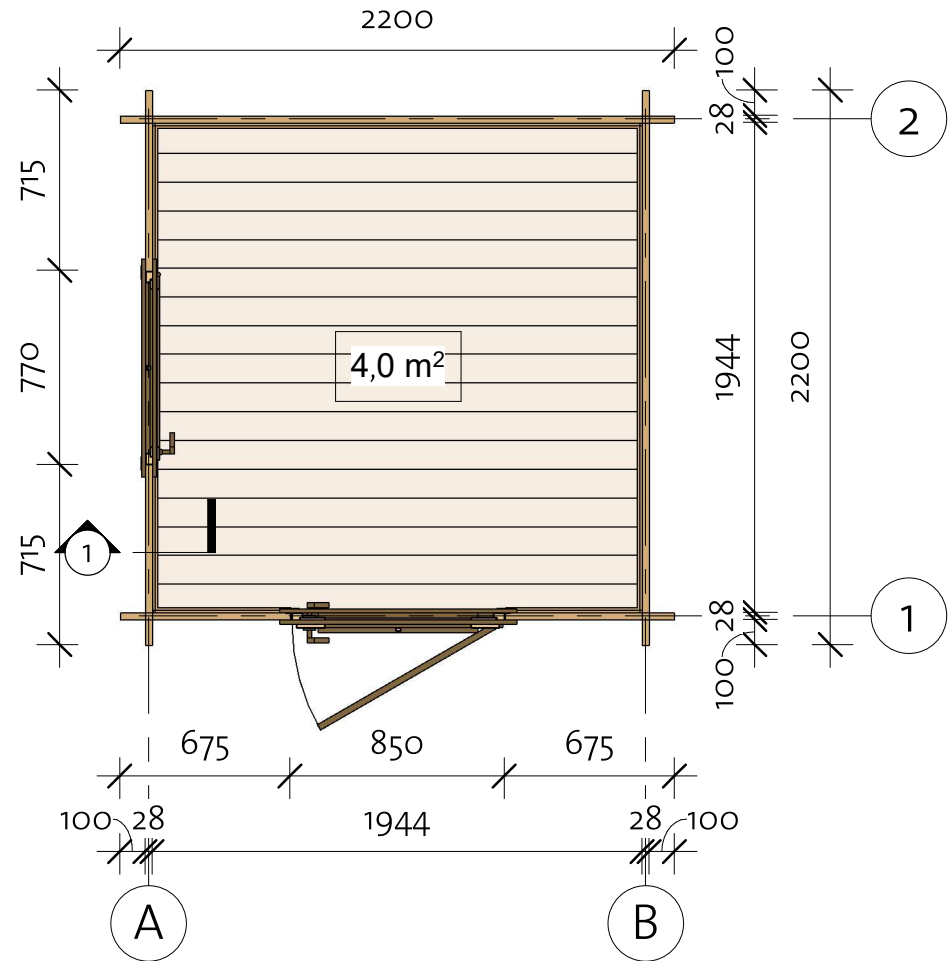
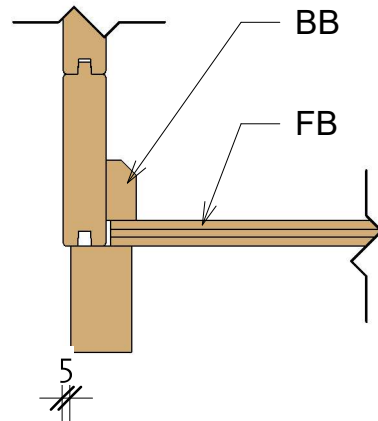
① Baseboard



Floor Schedule

Mark	Type	Profile	Count	Length
FB	FB 17x114		18	1938
BB	BB 20x40		4	2000

Dixon 28 (200x200)

Wall 1

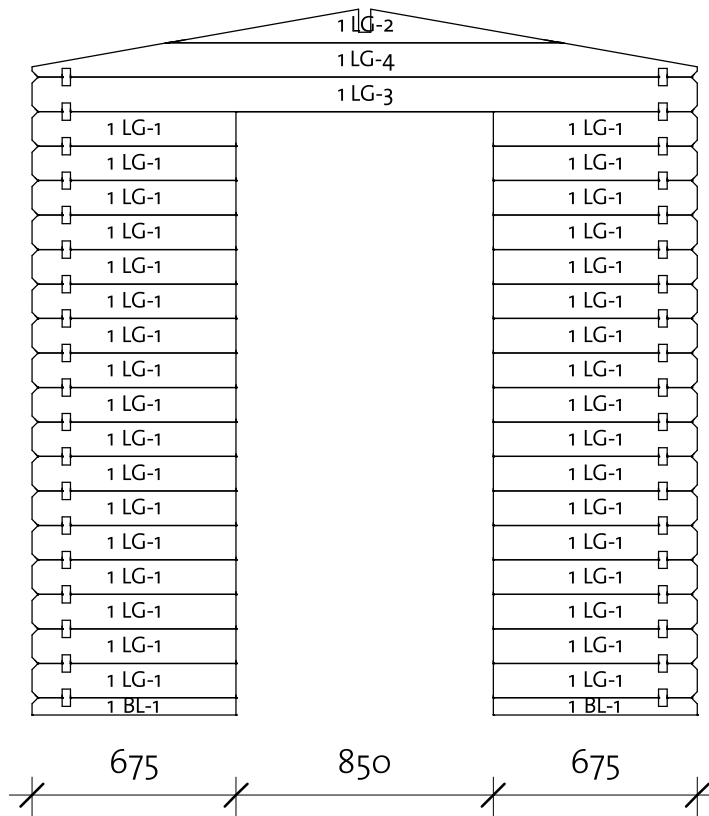
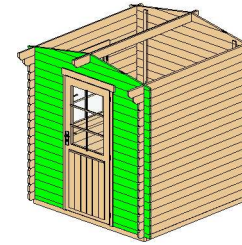



Wall 1			
Mark	Profile	Count	Cut Length

1BL-1	28x57	2	675
1LG-1	28x114	34	675
1LG-2*	28x114	1	1297
1LG-3	28x114	1	2200
1LG-4*	28x114	1	2200

* Gable - delivered premounted

Log Profile Wall 1	
Profile	Profile

28x57	
28x114	

Dixon 28 (200x200)

Wall 2

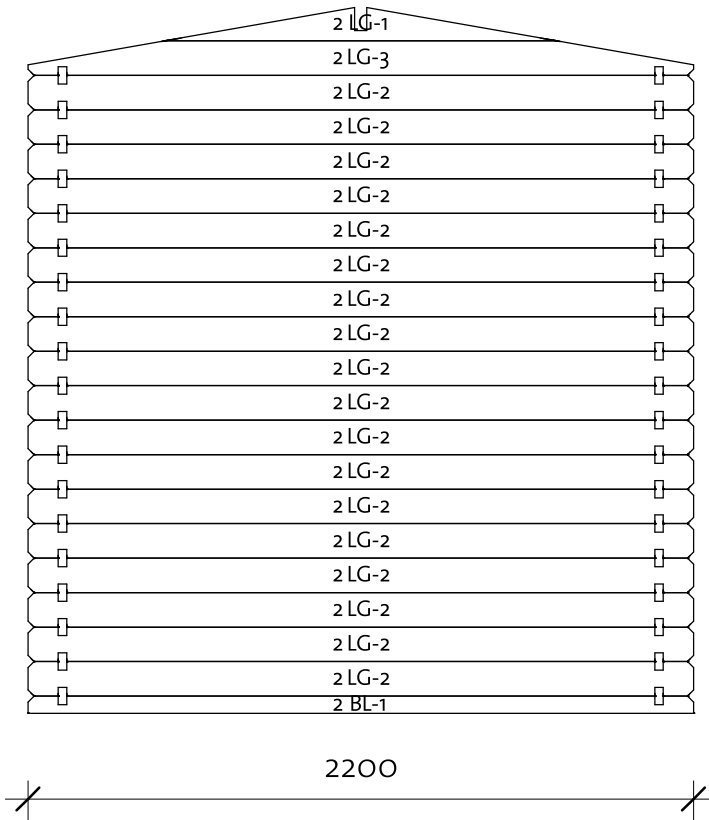
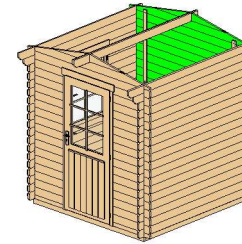

Wall 2			
Mark	Profile	Count	Cut Length

2BL-1	28x57	1	2200
2LG-1*	28x114	1	1297
2LG-2	28x114	18	2200
2LG-3*	28x114	1	2200

* Gable - delivered premounted

Log Profile Wall 2	
Profile	Profile

28x57	
28x114	

Dixon 28 (200x200)

Wall A

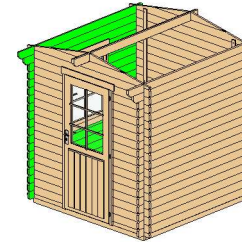

Wall A			
Mark	Profile	Count	Cut Length

ALG-1	28x114	18	715
ALG-2	28x114	8	2200
ALG-3	28x114	1	2300
ATL-1	28x114	1	2400

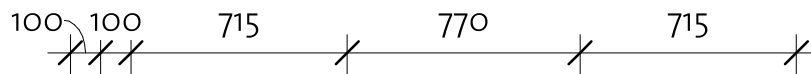
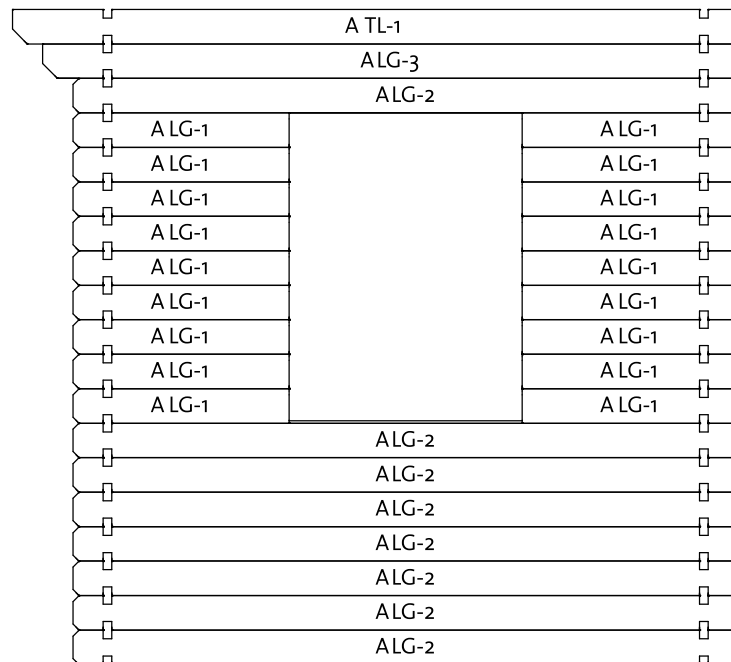

Log Profile Wall A	
Profile	Profile

28x114	
28x114	

Dixon 28 (200x200)

Wall B

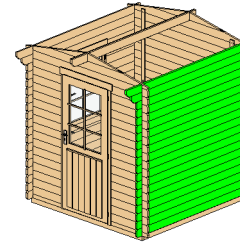

Wall B			
Mark	Profile	Count	Cut Length

BLG-1	28x114	17	2200
BLG-2	28x114	1	2300
BTL-1	28x114	1	2400

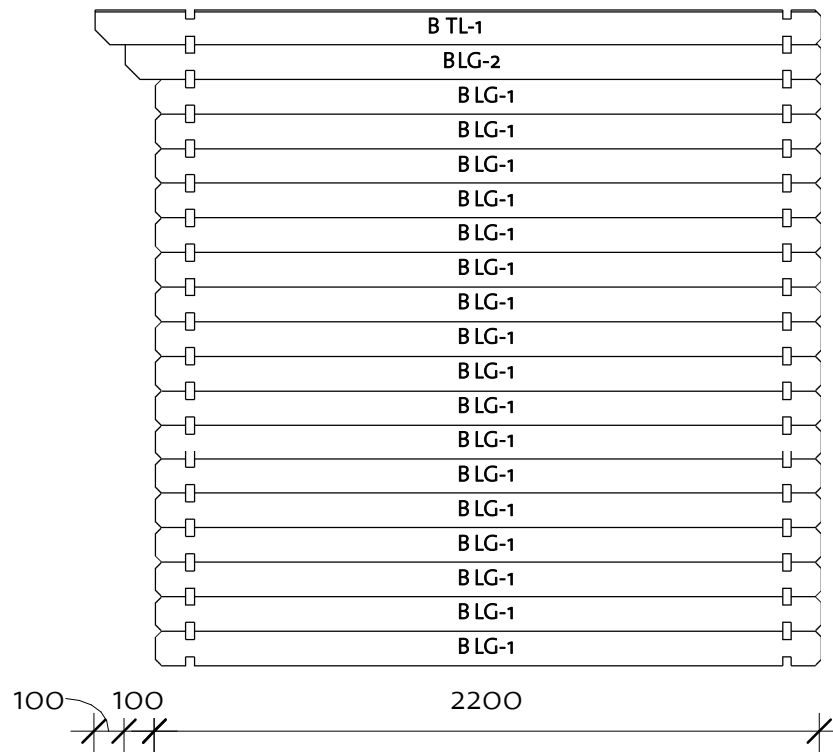



Log Profile Wall B	
Profile	Profile

28x114	
28x114	

Dixon 28 (200x200)

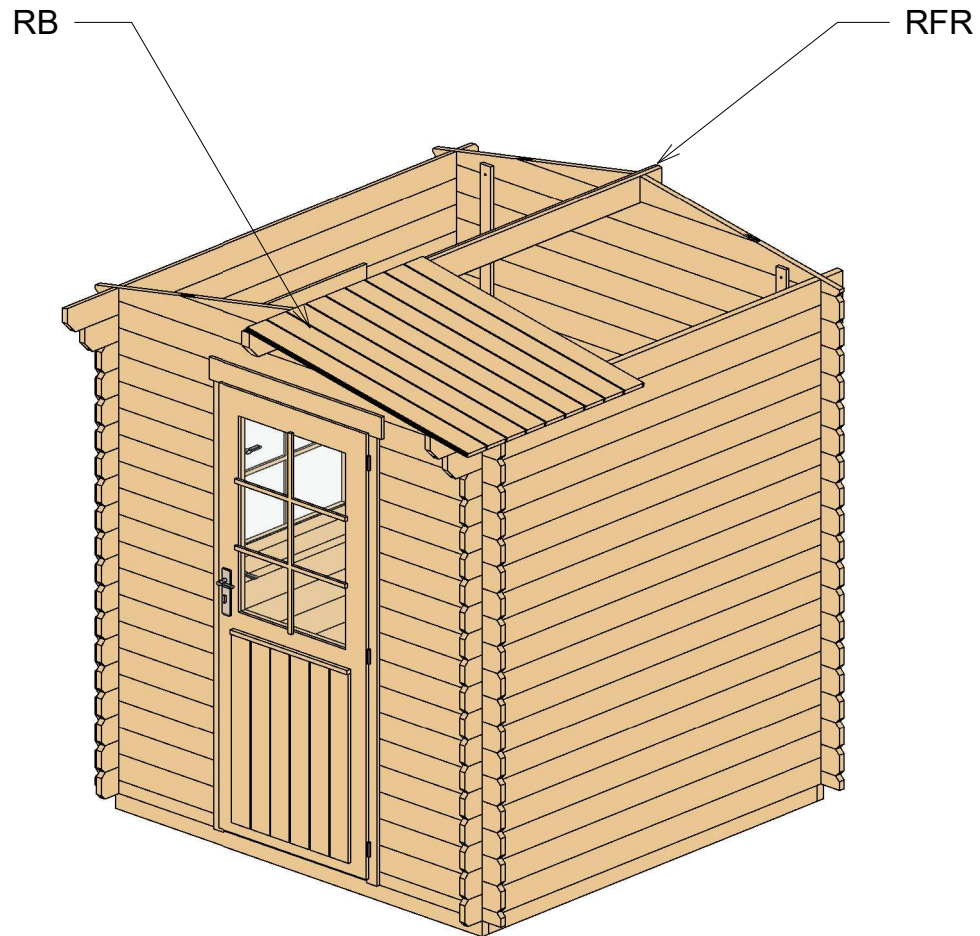
Roof 1



Roof				
Mark	Type	Profile	Count	Length
RFR	Ridge 40x120		1	2400
RB	17x114		42	1215

Dixon 28 (200x200)

Roof 2

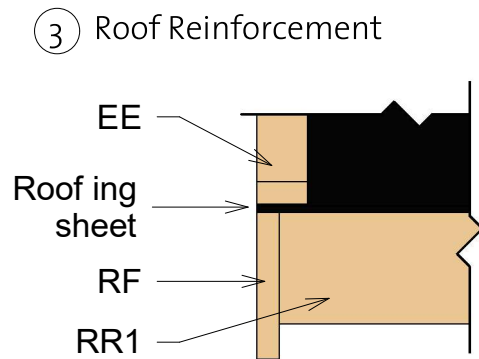
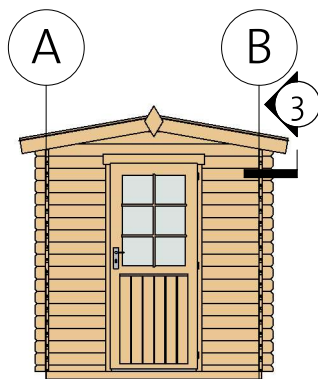
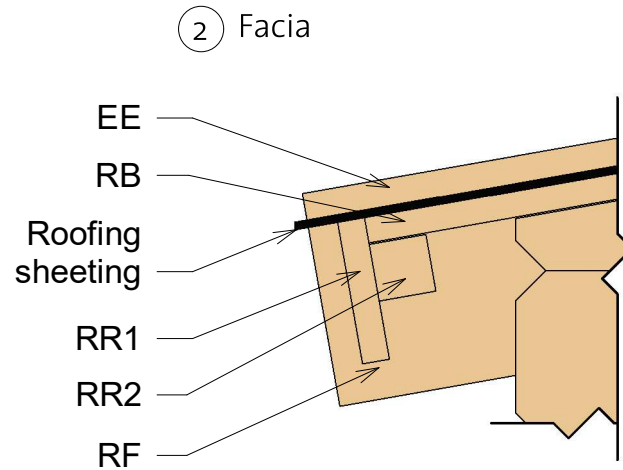
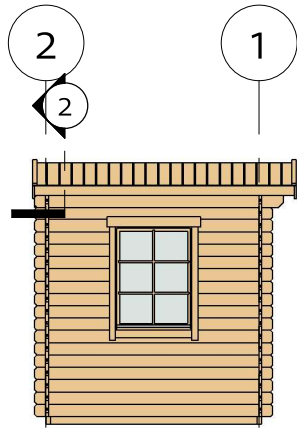

Fascia Schedule				
Mark	Type	Profile	Count	Length
EE	Eave Edging 18x40		4	1256
RF	Roof Fascia 18x120		4	1256
RR1	Roof reinforcement 18x95		2	2400
RR2	Roof reinforcement 38x38		2	2400

Dixon 28 (200x200)

Extras



Door Schedule				
Mark	Type	Width	Height	Count
BD3R	Basic door 3 right	840	1955	1
DCB6	Door Crossbar 6	--	--	1

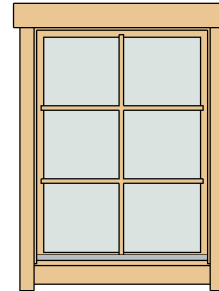

Window Schedule				
Mark	Type	Wdth	Height	Count
BW1R	Basic window 1 right	765	990	1
WCB6	Windows Crossbar 6	--	--	1

Fasteners & Extras		
Name	Type	Count

Hitblock	300-400 mm	
Screws	5,0 x 70	10
Bolts	M8 x 60	12
Nails	1,4 x 40	20
Screws	6,0 x 140	32
Screws	4,0 x 40	65
Screws	4,0 x 50	220

Family	Count
Romb	2

Type	Count	Length
Windboard 18x40	4	2200





Dixon 28 (200x200)

List of all items 1



Impregnated foundation beams

Mark	Type	Profile	Count	Length
------	------	---------	-------	--------

IFB1	IFB 40x70		5	1910
IFB2	IFB 40x70		2	1990





Roof

Mark	Type	Profile	Count	Length
------	------	---------	-------	--------

RFR	Ridge 40x120		1	2400
RB	17x114		42	1215



Fascia Schedule

Mark	Type	Profile	Count	Length
------	------	---------	-------	--------

EE	Eave Edging 18x40		4	1256
RF	Roof Fascia 18x120		4	1256
RR1	Roof reinforcement 18x95		2	2400
RR2	Roof reinforcement 38x38		2	2400

Floor Schedule

Mark	Type	Profile	Count	Length
------	------	---------	-------	--------

FB	FB 17x114		18	1938
BB	BB 20x40		4	2000

Dixon 28 (200x200)

List of all items 2

Wall 1			
Mark	Profile	Count	Cut Length

1BL-1	28x57	2	675
1LG-1	28x114	34	675
1LG-2*	28x114	1	1297
1LG-3	28x114	1	2200
1LG-4*	28x114	1	2200

Wall 2			
Mark	Profile	Count	Cut Length

2BL-1	28x57	1	2200
2LG-1*	28x114	1	1297
2LG-2	28x114	18	2200
2LG-3*	28x114	1	2200

* Gable - delivered premounted

Wall A			
Mark	Profile	Count	Cut Length

ALG-1	28x114	18	715
ALG-2	28x114	8	2200
ALG-3	28x114	1	2300
ATL-1	28x114	1	2400

Wall B			
Mark	Profile	Count	Cut Length

BLG-1	28x114	17	2200
BLG-2	28x114	1	2300
BTL-1	28x114	1	2400

Log Profiles	
Profile	Profile

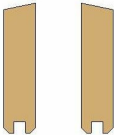
28x57	
28x114	

Log Profiles	
Profile	Profile

28x114	
--------	---